

COSMOS SQUARE SUSPENSION

D1010050-

base number LED Dimming Color Temperature Finish Options

- To build a product code in our configurator select the specify button on the base model # product page
- To build a manual product code on this datasheet choose from the options listed below in blue font and add the suffix to the base model #

GENERAL

Series: Cosmos Square
 Partner: Quasar
 Division: Design
 Installation: Suspension
 Product Type: Chandelier
 Mounting Location: Ceiling

PHYSICAL

Shape: Square
 Length (mm): 1500
 Length (in): 59 1/16
 Width (mm): 305
 Width (in): 12
 Height (mm): 400
 Height (in): 15 3/4
 Max. Overall Height (mm): 2450
 Max. Overall Height (in): 94 1/2
 Weight (kg): 8
 Weight (lbs): 17.64
[Fixture Finish: NIC / BRA / BBR](#)
 Fixture Material: Metal
 Cable Details: 2000mm Cable
 Upon Request: Custom Sizes Optional Dowlight upon request

ELECTRICAL

Number of Lamps: 135
 Lamp Type: LED
 Input Wattage (W): 81
 Bulb Included: Bulb Included
 Max. Wattage Per Lamp (W): 0.6
[Dimming: Tri-Mode \(Non-Dimming and Phase Dimming \(120Vac only\) and 0-10V Dimming\)](#)
 Driver Included: Yes
 Driver Location: Integrated
 Driver Type: Constant Voltage - Universal
 Driver Class: Class 2
 Input Voltage (V): 120 - 277
 Output Voltage (V): 12

LED

Number of LEDs: 135
[Color Temperature \(°K\): 2400 / 2800](#)
 Max. Delivered Lumen (lm): 4050 (2800K)
 CRI: >90 CRI
 Lamp Life (hrs): 50000

OPTICAL

RATINGS AND CERTIFICATIONS

Certified By: Certified for North American Standards
 IP rating: IP20

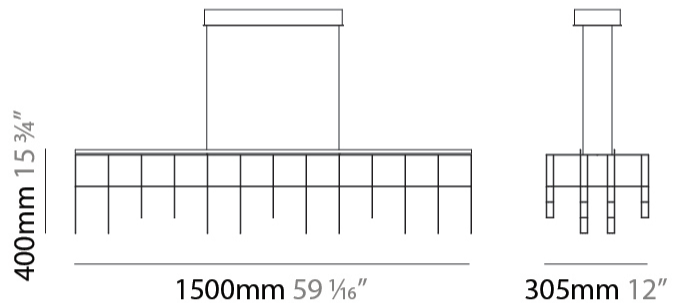

COSMOS SQUARE SUSPENSION

D1010050-

PROJECT

TYPE

SPECIFIER

QUANTITY

DATE

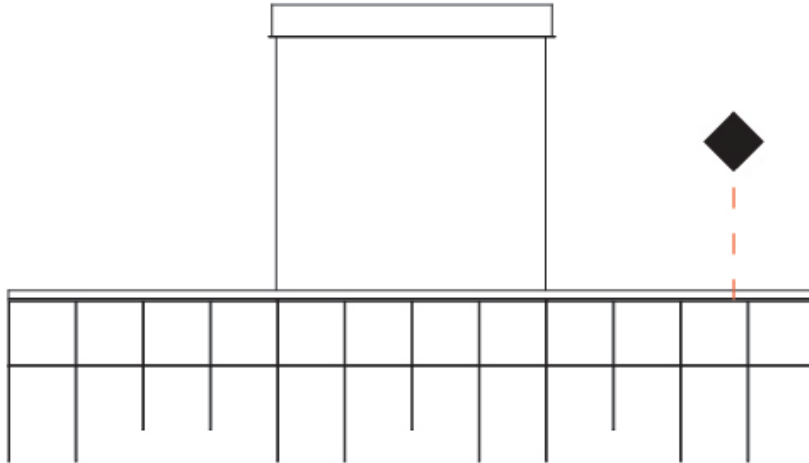

COSMOS SQUARE SUSPENSION

D1010051-

base number LED Dimming Color Temperature Finish Options

- To build a product code in our configurator select the specify button on the base model # product page
- To build a manual product code on this datasheet choose from the options listed below in blue font and add the suffix to the base model #

GENERAL

Series: Cosmos Square
 Partner: Quasar
 Division: Design
 Installation: Suspension
 Product Type: Chandelier
 Mounting Location: Ceiling

PHYSICAL

Shape: Square
 Length (mm): 3000
 Length (in): 118 1/8
 Width (mm): 305
 Width (in): 12
 Height (mm): 400
 Height (in): 15 3/4
 Max. Overall Height (mm): 2450
 Max. Overall Height (in): 94 1/2
 Weight (kg): 16
 Weight (lbs): 35.27
[Fixture Finish: NIC / BRA / BBR](#)
 Fixture Material: Metal
 Cable Details: 2000mm Cable
 Upon Request: Custom Sizes Optional Dowlight upon request

ELECTRICAL

Number of Lamps: 258
 Lamp Type: LED
 Input Wattage (W): 155
 Max. Wattage Per Lamp (W): 0.6
[Dimming: 0-10V Dimming / Phase Dimming \(120Vac Only\)](#)
 Driver Included: Yes
 Driver Location: Integrated
 Driver Type: Constant Voltage - Universal
 Driver Class: Class 1
 Input Voltage (V): 120 - 277
 Output Voltage (V): 12

LED

Number of LEDs: 258
[Color Temperature \(°K\): 2400 / 2800](#)
 Max. Delivered Lumen (lm): 7740 (2800K)
 CRI: >90 CRI
 Lamp Life (hrs): 50000

OPTICAL

RATINGS AND CERTIFICATIONS

Certified By: Certified for North American Standards
 IP rating: IP20

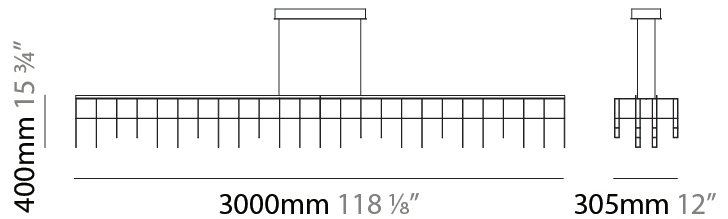

COSMOS SQUARE SUSPENSION

D1010051-

PROJECT

TYPE

SPECIFIER

QUANTITY

DATE

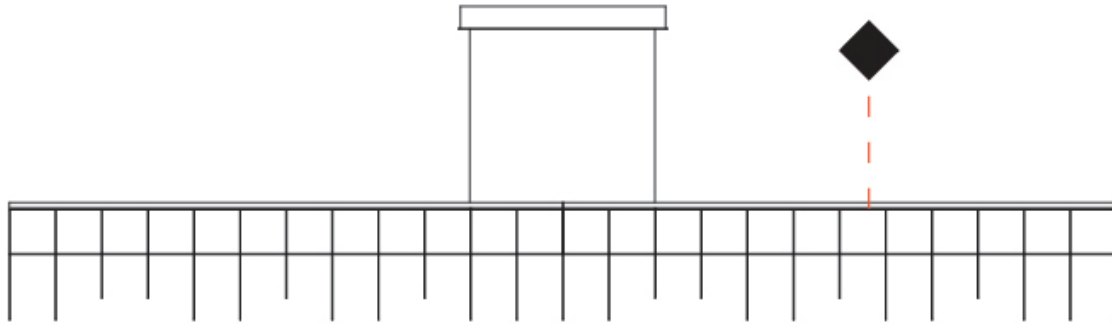

COSMOS SQUARE SUSPENSION

D101741-

base number LED Color Finish
 Dimming Temperature Options

- To build a product code in our configurator select the specify button on the base model # product page
- To build a manual product code on this datasheet choose from the options listed below in blue font and add the suffix to the base model #

GENERAL

Series: Cosmos Square
 Partner: Quasar
 Division: Design
 Installation: Suspension
 Product Type: Chandelier
 Mounting Location: Ceiling

PHYSICAL

Shape: Rectangle
 Length (mm): 875
 Length (in): 34 ⁷/₁₆"
 Width (mm): 395
 Width (in): 15 ⁹/₁₆"
 Height (mm): 250
 Height (in): 9 ¹³/₁₆"
 Max. Overall Height (mm): 2250
 Max. Overall Height (in): 88 ⁹/₁₆"
 Weight (kg): 4
 Weight (lbs): 8.82
 Fixture Finish: [NIC / BRA / BBR](#)
 Fixture Material: Metal
 Cable Details: 2000mm Cable
 Upon Request: Custom Sizes Optional Dowlight upon request

ELECTRICAL

Lamp Type: LED
 Input Wattage (W): 57.6
 Dimming: [Non-Dimming / Phase Dimming \(120vac Only\)](#)
 Driver Included: Yes
 Driver Location: Integrated
 Driver Type: Constant Voltage - Universal
 Driver Class: Class 2
 Input Voltage (V): 120 - 277
 Output Voltage (V): 12
 Upon Request: (Not included - see components) Integral: 0-10Vdc dimming

LED

Number of LEDs: 96
 Color Temperature (°K): [2400 / 2800](#)
 Max. Delivered Lumen (lm): 2880 (2800K)
 CRI: >90 CRI
 Lamp Life (hrs): 50000

OPTICAL

RATINGS AND CERTIFICATIONS

Certified By: Certified for North American Standards
 IP rating: IP20

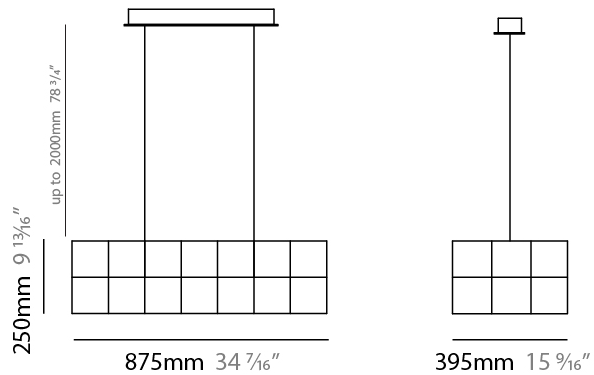
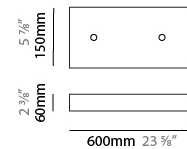
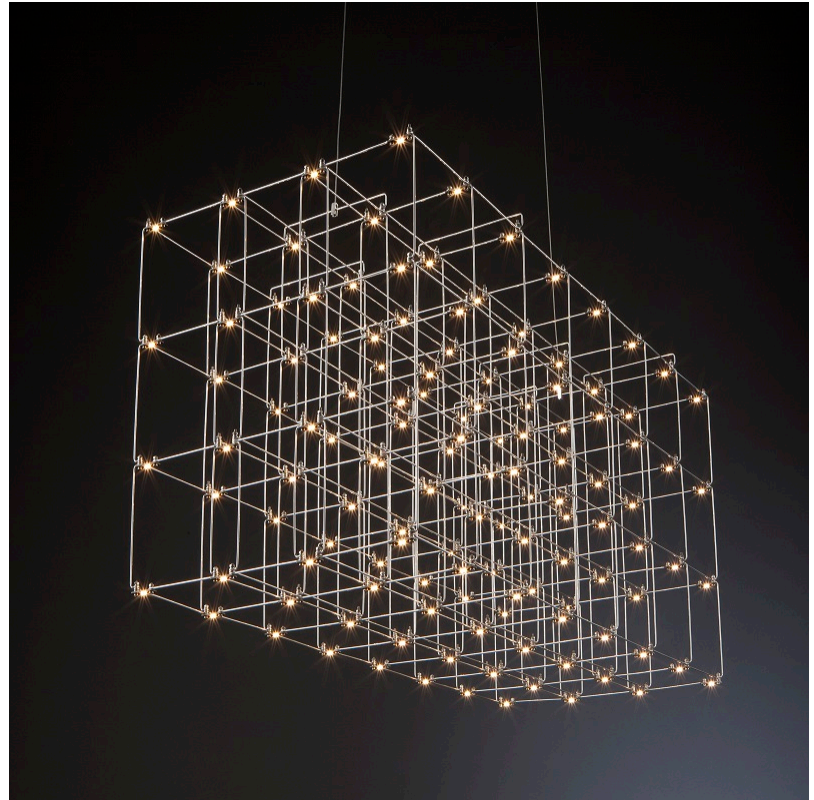

COSMOS SQUARE SUSPENSION

D101741-

PROJECT	_____
TYPE	_____
SPECIFIER	_____
QUANTITY	_____
DATE	_____

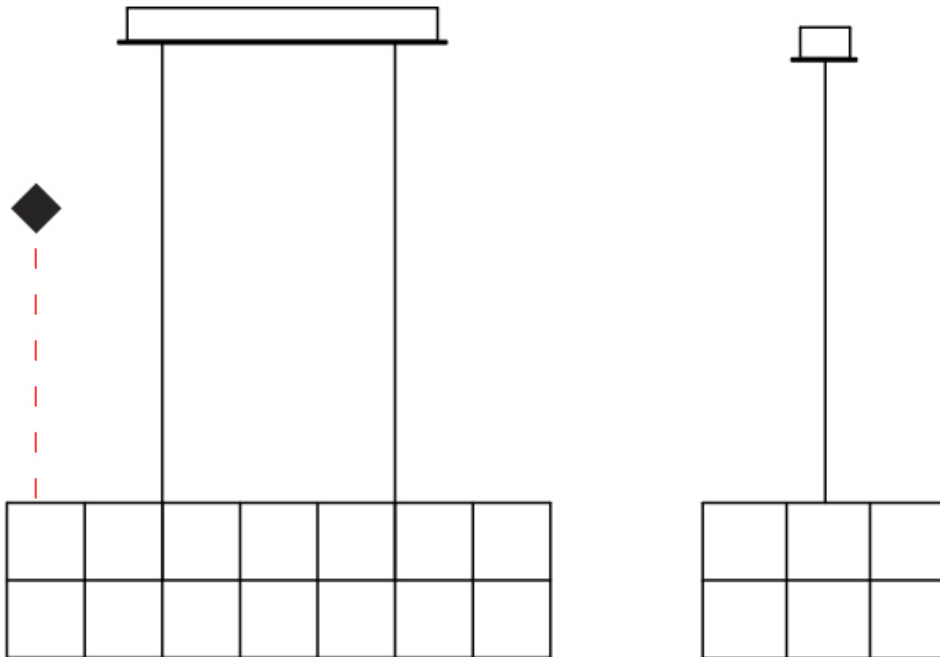

COSMOS SQUARE SUSPENSION

D101742-

base number LED Color Finish
 Dimming Temperature Options

PROJECT _____
 TYPE _____
 SPECIFIER _____
 QUANTITY _____
 DATE _____

- To build a product code in our configurator select the specify button on the base model # product page
- To build a manual product code on this datasheet choose from the options listed below in blue font and add the suffix to the base model #

GENERAL

Series: Cosmos Square
 Partner: Quasar
 Division: Design
 Installation: Suspension
 Product Type: Chandelier
 Mounting Location: Ceiling

PHYSICAL

Shape: Rectangle
 Length (mm): 875
 Length (in): 34 ⁷/₁₆
 Width (mm): 395
 Width (in): 15 ⁹/₁₆
 Height (mm): 375
 Height (in): 14 ³/₄
 Max. Overall Height (mm): 2375
 Max. Overall Height (in): 93 ¹/₂
 Weight (kg): 4.5
 Weight (lbs): 9.92
 Fixture Finish: [NIC / BRA / BBR](#)
 Fixture Material: Metal
 Cable Details: 2000mm Cable
 Upon Request: Custom Sizes Optional Dowlight upon request

ELECTRICAL

Lamp Type: LED
 Input Wattage (W): 76.8
 Dimming: [Non-Dimming / Phase Dimming \(120vac Only\)](#)
 Driver Included: Yes
 Driver Location: Integrated
 Driver Type: Constant Voltage - Universal
 Driver Class: Class 2
 Input Voltage (V): 120 - 277
 Output Voltage (V): 12
 Upon Request: (Not included - see components) Integral: 0-10Vdc dimming

LED

Number of LEDs: 128
 Color Temperature (°K): [2400 / 2800](#)
 Max. Delivered Lumen (lm): 3840 (2800K)
 CRI: >90 CRI
 Lamp Life (hrs): 50000

OPTICAL

RATINGS AND CERTIFICATIONS

Certified By: Certified for North American Standards
 IP rating: IP20

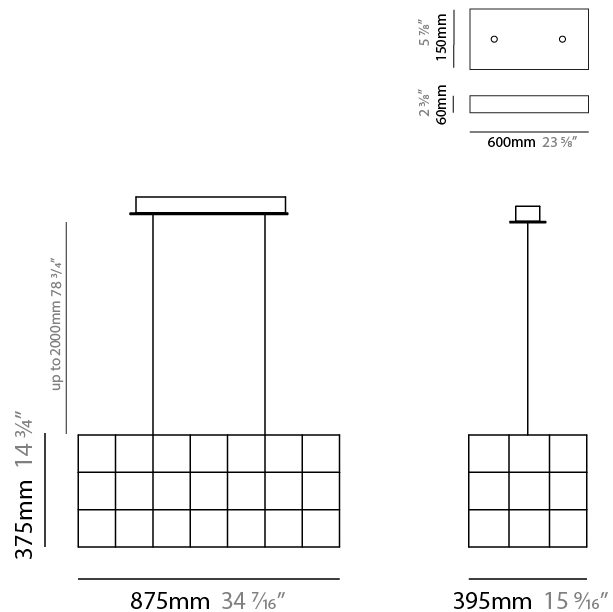
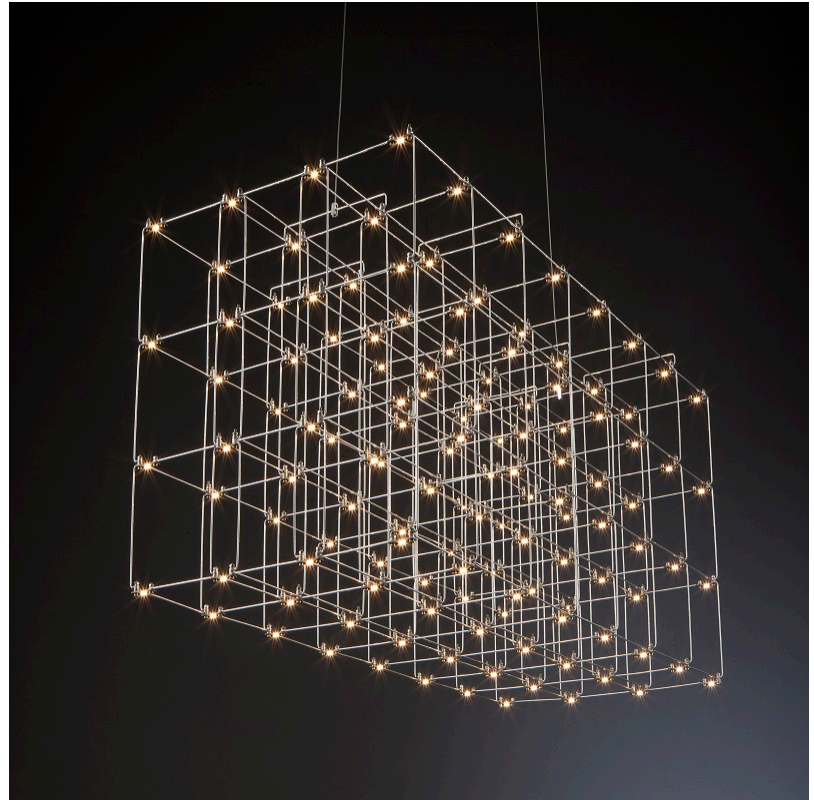

COSMOS SQUARE SUSPENSION

D101742-

PROJECT _____

TYPE _____

SPECIFIER _____

QUANTITY _____

DATE _____

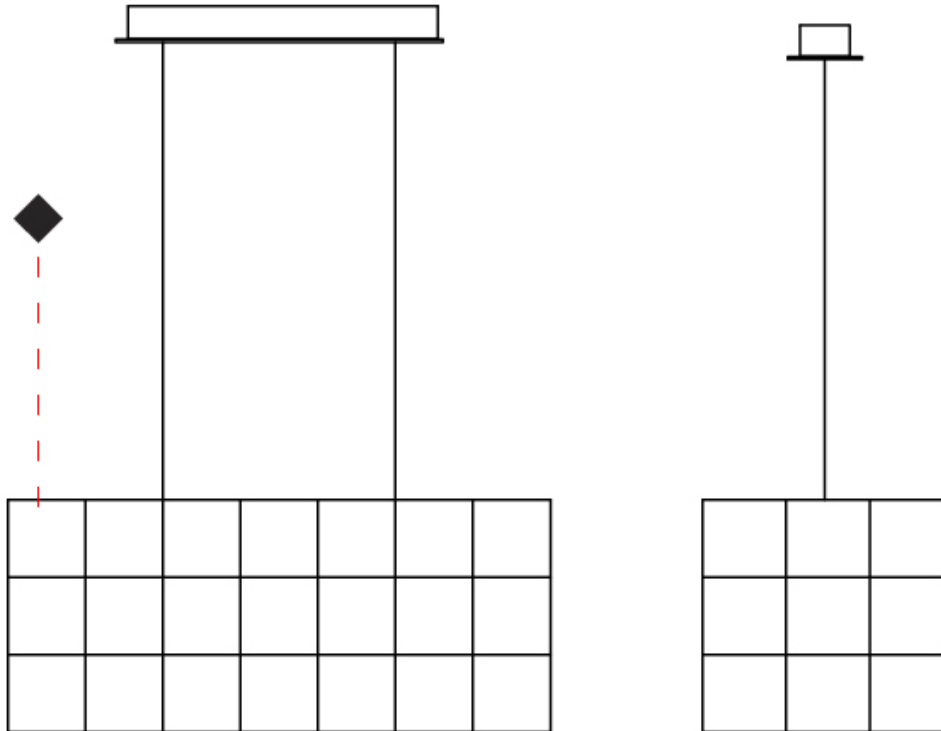

D

COSMOS SQUARE SUSPENSION

D101743-

base number LED Color Finish
 Dimming Temperature Options

- To build a product code in our configurator select the specify button on the base model # product page
- To build a manual product code on this datasheet choose from the options listed below in blue font and add the suffix to the base model #

GENERAL

Series: Cosmos Square
 Partner: Quasar
 Division: Design
 Installation: Suspension
 Product Type: Chandelier
 Mounting Location: Ceiling

PHYSICAL

Shape: Square
 Length (mm): 1000
 Length (in): 39 ³/₈"
 Width (mm): 1000
 Width (in): 39 ³/₈"
 Height (mm): 850
 Height (in): 33 ⁷/₁₆"
 Max. Overall Height (mm): 2850
 Max. Overall Height (in): 112 ³/₁₆"
 Weight (kg): 24
 Weight (lbs): 52.91
 Fixture Finish: [NIC / BRA / BBR](#)
 Fixture Material: Metal
 Cable Details: 2000mm Cable
 Upon Request: Custom Sizes Optional Dowlight upon request

ELECTRICAL

Lamp Type: LED
 Input Wattage (W): 328.8
 Dimming: [Non-Dimming / Phase Dimming \(120vac Only\)](#)
 Driver Included: Yes
 Driver Location: Integrated
 Driver Type: Constant Voltage - Universal
 Driver Class: Class 2
 Input Voltage (V): 120 - 277
 Output Voltage (V): 12

LED

Number of LEDs: 548
 Color Temperature (°K): [2400 / 2800](#)
 Max. Delivered Lumen (lm): 16440 (2800K)
 CRI: >90 CRI
 Lamp Life (hrs): 50000

OPTICAL

RATINGS AND CERTIFICATIONS

Certified By: Certified for North American Standards
 IP rating: IP20

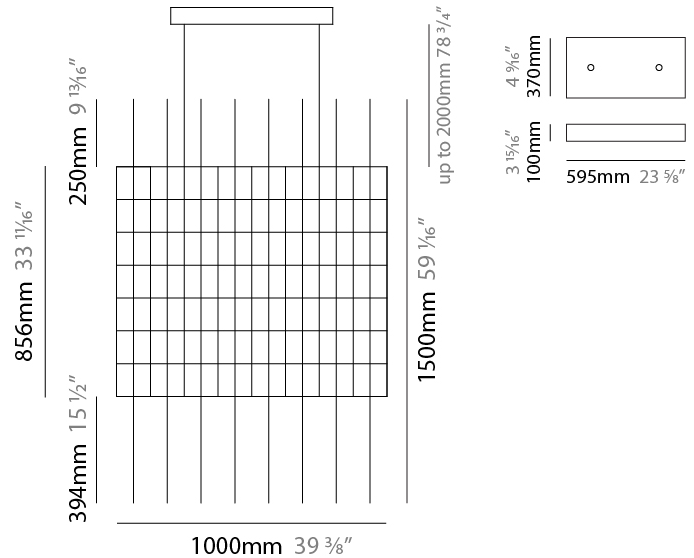
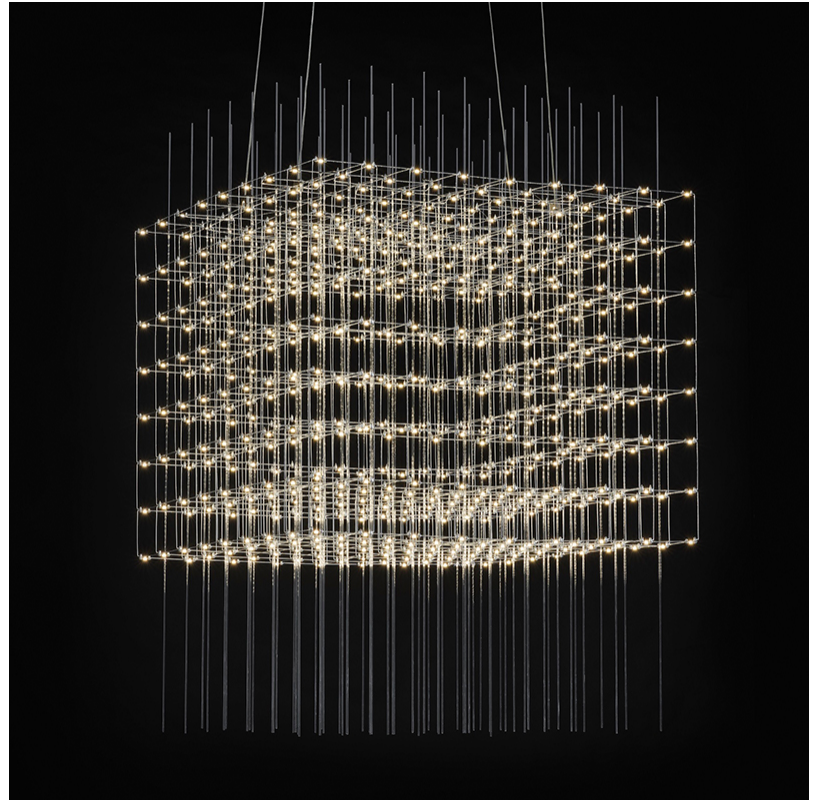

COSMOS SQUARE SUSPENSION

D101743-

PROJECT

TYPE

SPECIFIER

QUANTITY

DATE

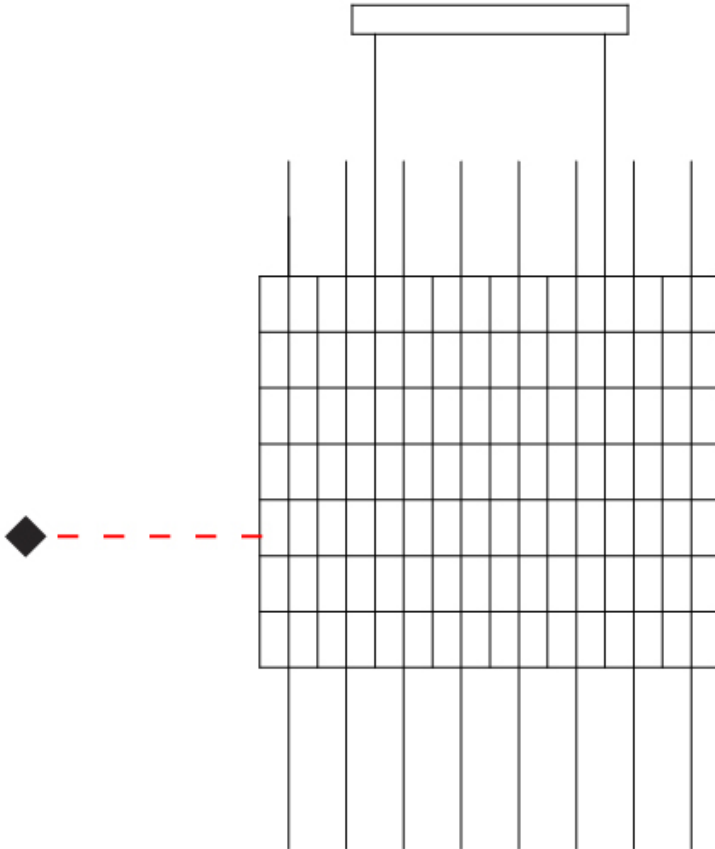

D

COSMOS SQUARE SUSPENSION

D101944-

base number LED Dimming Color Temperature Finish Options

- To build a product code in our configurator select the specify button on the base model # product page
- To build a manual product code on this datasheet choose from the options listed below in blue font and add the suffix to the base model #

GENERAL

Series: Cosmos Square
 Partner: Quasar
 Division: Design
 Installation: Suspension
 Product Type: Chandelier
 Mounting Location: Ceiling

PHYSICAL

Shape: Square
 Length (mm): 1000
 Length (in): 39 ³/₈"
 Width (mm): 1000
 Width (in): 39 ³/₈"
 Height (mm): 850
 Height (in): 33 ⁷/₁₆"
 Max. Overall Height (mm): 2850
 Max. Overall Height (in): 112 ³/₁₆"
 Weight (kg): 24
 Weight (lbs): 52.91
[Fixture Finish: NIC / BRA / BBR](#)
 Fixture Material: Metal
 Cable Details: 2000mm Cable
 Upon Request: Custom Sizes Optional Dowlight upon request

ELECTRICAL

Lamp Type: LED
 Input Wattage (W): 328.8
[Dimming: 0-10V Dimming / Phase Dimming \(120Vac Only\)](#)
 Driver Included: Yes
 Driver Location: Integrated
 Driver Type: Constant Voltage - Universal
 Driver Class: Class 2
 Input Voltage (V): 120 - 277
 Output Voltage (V): 12

LED

Number of LEDs: 548
[Color Temperature \(°K\): 2400 / 2800](#)
 Max. Delivered Lumen (lm): 16440 (2800K)
 CRI: >90 CRI
 Lamp Life (hrs): 50000

OPTICAL

RATINGS AND CERTIFICATIONS

Certified By: Certified for North American Standards
 IP rating: IP20

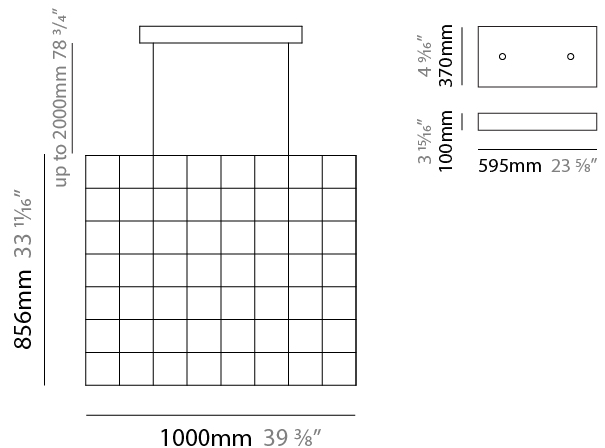
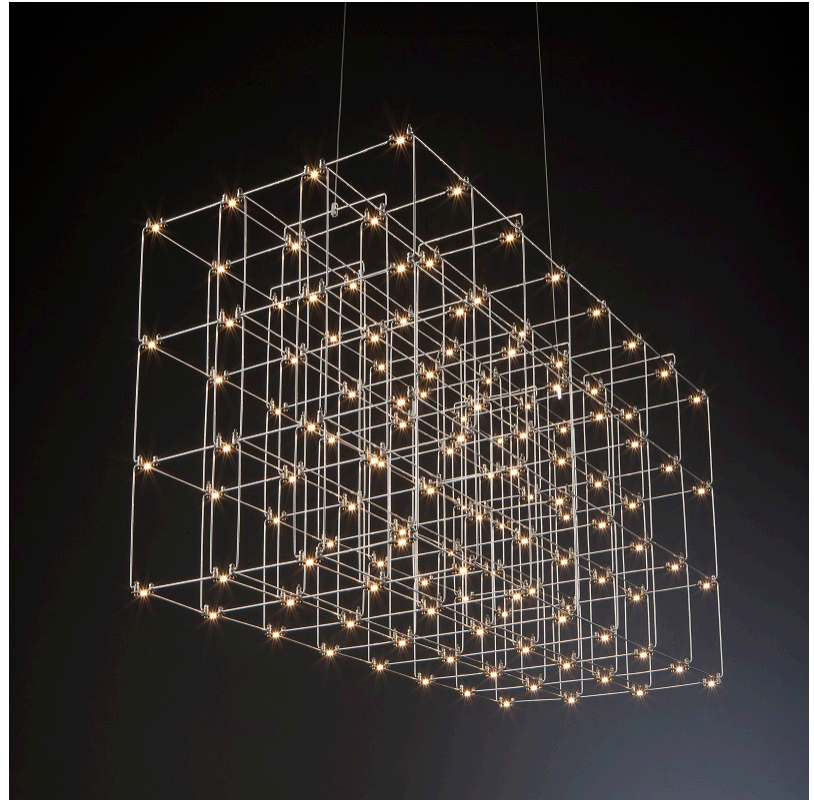

COSMOS SQUARE SUSPENSION

D101944-

PROJECT _____

TYPE _____

SPECIFIER _____

QUANTITY _____

DATE _____

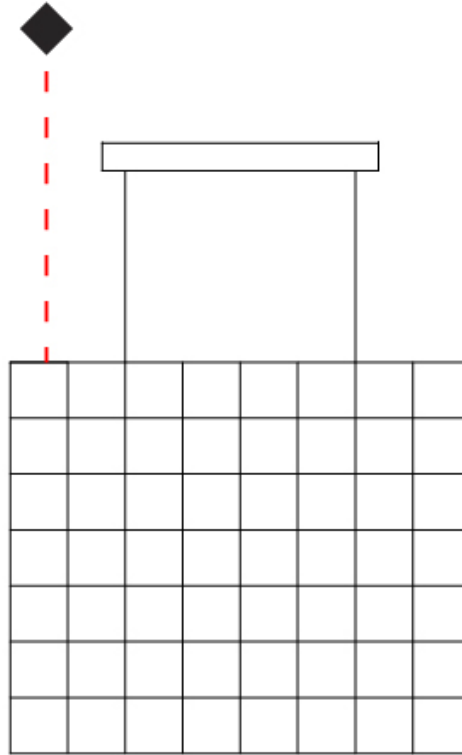

PROJECT
TYPE
SPECIFIER
QUANTITY
DATE

COSMOS SQUARE PORTABLE

D104214-

base number	LED	Color	Finish
	Dimming	Temperature	Options

- To build a product code in our configurator select the specify button on the base model # product page
- To build a manual product code on this datasheet choose from the options listed below in blue font and add the suffix to the base model #

GENERAL

Series: Cosmos Square
Partner: Quasar
Division: Design
Installation: Portable
Product Type: Floor
Mounting Location: Floor

PHYSICAL

Shape: Square
Length (mm): 400
Length (in): 15 3/4
Width (mm): 400
Width (in): 15 3/4
Height (mm): 1260
Height (in): 49 5/8
Weight (kg): 3
Fixture Finish: NIC / BRA / BBR
Fixture Material: Metal
Upon Request: Custom Sizes

ELECTRICAL

Lamp Type: LED
Input Wattage (W): 38.4
Dimming: Non-Dimmable
Driver Included: No
Driver Location: Inline Transformer Plug
Driver Type: Constant Voltage - Universal
Driver Class: Class 2
Input Voltage (V): 120 - 277
Output Voltage (V): 12
Upon Request: Phase dimming with remote driver

LED

Number of LEDs: 64
Color Temperature (°K): 2400 / 2800
Max. Delivered Lumen (lm): 1920 (2800K)
CRI: >90 CRI
Lamp Life (hrs): 50000

OPTICAL

RATINGS AND CERTIFICATIONS

Certified By: Certified for North American Standards
IP rating: IP20



Ø400mm 15 3/4"

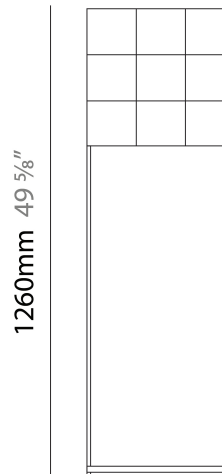

COSMOS SQUARE PORTABLE

D104214-

PROJECT

TYPE

SPECIFIER

QUANTITY

DATE

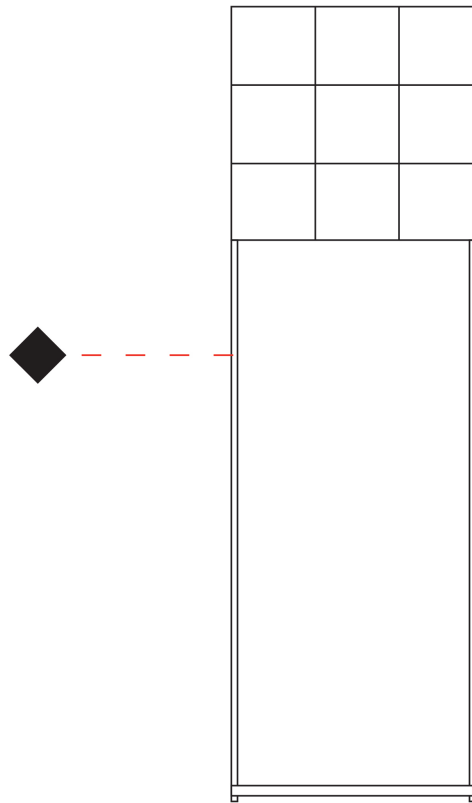

COSMOS SQUARE PORTABLE

D104215-

base number LED Dimming Color Temperature Finish Options

PROJECT _____
 TYPE _____
 SPECIFIER _____
 QUANTITY _____
 DATE _____

- To build a product code in our configurator select the specify button on the base model # product page
- To build a manual product code on this datasheet choose from the options listed below in blue font and add the suffix to the base model #

GENERAL

Series: Cosmos Square
 Partner: Quasar
 Division: Design
 Installation: Portable
 Product Type: Floor
 Mounting Location: Floor

PHYSICAL

Shape: Square
 Length (mm): 400
 Length (in): 15 ¾
 Width (mm): 400
 Width (in): 15 ¾
 Height (mm): 1480
 Height (in): 58 ¼
 Weight (kg): 3
[Fixture Finish: NIC / BRA / BBR](#)
 Fixture Material: Metal
 Upon Request: Custom Sizes

ELECTRICAL

Lamp Type: LED
 Input Wattage (W): 38.4
[Dimming: Non-Dimmable](#)
 Driver Included: No
 Driver Location: Inline Transformer Plug
 Driver Type: Constant Voltage - Universal
 Driver Class: Class 2
 Input Voltage (V): 120 - 277
 Output Voltage (V): 12
 Upon Request: Phase dimming with remote driver

LED

Number of LEDs: 64
[Color Temperature \(°K\): 2400 / 2800](#)
 Max. Delivered Lumen (lm): 1920 (2800K)
 CRI: >90 CRI
 Lamp Life (hrs): 50000

OPTICAL

RATINGS AND CERTIFICATIONS

Certified By: Certified for North American Standards
 IP rating: IP20



Ø400mm 15 ¾"



COSMOS SQUARE PORTABLE

D104215-

PROJECT _____

TYPE _____

SPECIFIER _____

QUANTITY _____

DATE _____

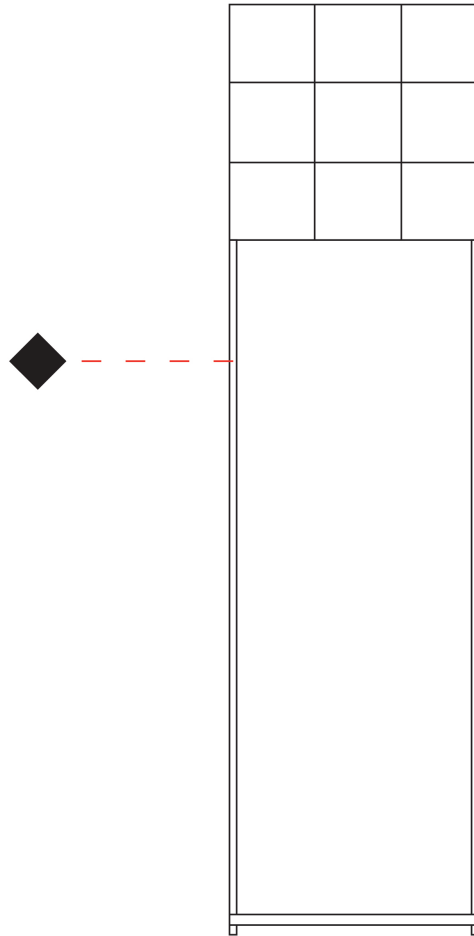

D

PROJECT _____

TYPE _____

SPECIFIER _____

QUANTITY _____

DATE _____

Fixture Finish

Nickel - NIC



Brass - BRA



Black Brass - BBR

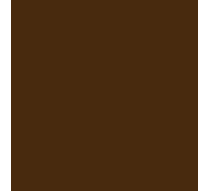

Digital: Not all screens are calibrated the same, and therefore, colors will appear differently between screens.

Physical: When texture is involved, there will be variations in color, character and tone within a product series and between product families.











Brass, nickel and copper are natural minerals and can potentially change color and show marks over time. We cannot guarantee the color appearance as the material transforms.













LEGEND

 floor-mounted	 pivotable	 special LED (upon request) RGB, RGBW, tunable, gold+, meat+, art+, fashion+
 wall and ceiling: recessed and surface mounted	 rotating	 warm dim / natural dimming LED
 ceiling-mounted and wall-mounted	 illuminate tilted	 rechargeable battery powered
 wall-mounted	 color of suspension cable	 fixture with natural vivid LED (upon request)
 omni-directional light distribution	 length of suspension cable	 color rendering index
 direct light distribution	 reflector degree selection	 color temperature
 direct/indirect light distribution	 super spot	 lumen (luminous flux)
 indirect light distribution	 lens	 efficacy (lumens per watt)
 asymmetric light distribution	 lens pack	 Unified Glare Rating (UGR) range from 5-40
 aura light distribution	 shine ring	 marine grade (AISI 316 stainless steel)
 round wall or ceiling cut-out	 integrated shine ring with diffuser	 walk on
 square wall or ceiling cut-out	 free individual colors 01-29	 drive on
 the supplied jig specifies the cutout dimensions	 individual colors: 00 (free of charge), 01-25 (extra charge)	 Dark Sky Compliance
 minimum distance (meters) lamp - object	 luminaire part to be colored (F1)	 Americans with Disabilities Act (less than 4" off the wall located between 27"-84" from floor)
 recessed depth	 luminaire part to be colored (F2)	 lamp protected against explosion
 ceiling thickness in mm	 luminaire part to be colored (F3)	 blown glass using traditional methods by master glass blower
 ceiling thickness selection	 luminaire part to be colored (F4)	 acoustic material
 dimmable DP (phase), DV (0-10V), DD (dali), DS (step-dim)	 luminaire part to be colored (F5)	 protection class I, protection insulation
 included or excluded LED driver/transformer/control gear	 color of 3-circuit adaptor	 protection class II, protection insulation
 separately switchable	 indirect diffuser	 ETL Certified to UL and CSA Standards
 sensor	 direct diffuser	 UL Certified to UL and CSA Standards
 remote control	 ball-proof (upon request)	 CSA Certified to UL and CSA Standards
 available upon request	 accessory	 Certified for North American Standards

IP RATING

 IP20	protected against ingress of solid bodies greater than 12.5mm (finger)
 IP33	protected against ingress of solid bodies greater than 2.5mm protected against sprays of water up to 60 degrees from the vertical (rain)
 IP40	protected against ingress of solid bodies greater than 1mm (wire) no protection against the ingress of moisture
 IP43	protected against ingress of solid bodies greater than 1mm (wire) protected against sprays of water up to 60 degrees from the vertical (rain)
 IP44	protected against ingress of solid bodies greater than 1mm (wire) protected against water splashed from all directions
 IP54	protected against limited ingress of dust (wet rooms/covered outdoor areas) protected against water splashed from all directions
 IP65	protected against ingress of dust protected against jets of water
 IP66	protected against ingress of dust protected against powerful jets of water or heavy seas
 IP67	protected against ingress of dust protected against immersion of water between 15cm - 1m for 30 minutes
 IP68	protected against ingress of dust protected against immersion of water under pressure for long periods

IK RATING

 IK01	protected against 0.14 joules impact (equivalent to 0.25kg mass dropped from 56mm above the surface)
 IK02	protected against 0.2 joules impact (equivalent to 0.25kg mass dropped from 80mm above the surface)
 IK03	protected against 0.35 joules impact (equivalent to 0.25kg mass dropped from 140mm above the surface)
 IK04	protected against 0.5 joules impact (equivalent to 0.25kg mass dropped from 200mm above the surface)
 IK05	protected against 0.7 joules impact (equivalent to 0.25kg mass dropped from 280mm above the surface)
 IK06	protected against 1 joules impact (equivalent to 0.25kg mass dropped from 400mm above the surface)
 IK07	protected against 2 joules impact (equivalent to 0.5kg mass dropped from 400mm above the surface)
 IK08	protected against 5 joules impact (equivalent to 1.7kg mass dropped from 300mm above the surface)
 IK09	protected against 10 joules impact (equivalent to 5.0kg mass dropped from 200mm above the surface)
 IK10	protected against 20 joules impact (equivalent to 5.0kg mass dropped from 400mm above the surface)